

INTERIOR ELEVATION

INSULATION TYPE: HAIRCELL
CFC-FREE
EXPANDED POLYSTYRENE
R= 6.64/U= 0.15
(ALSO AVAILABLE WITH
25ga STEEL BACKER)

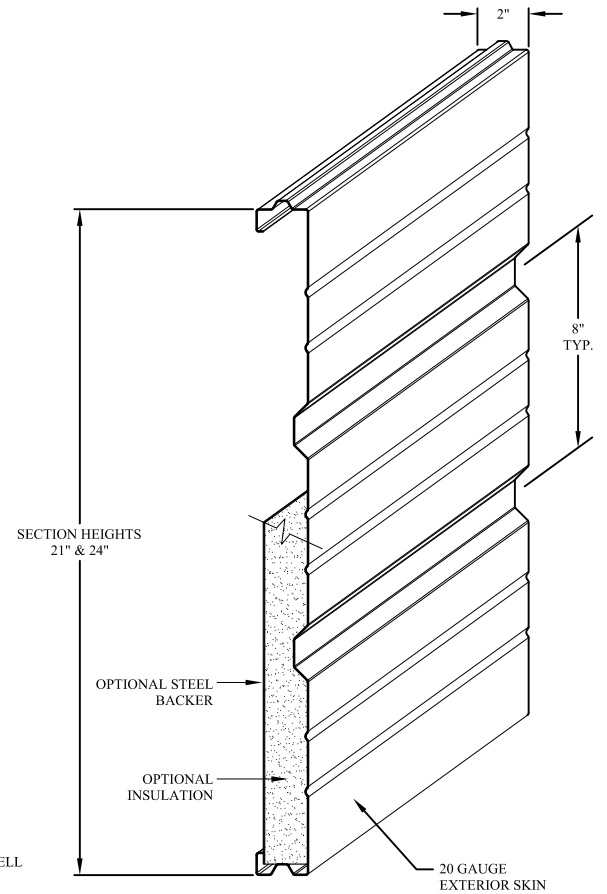

ISOMETRIC PROFILE

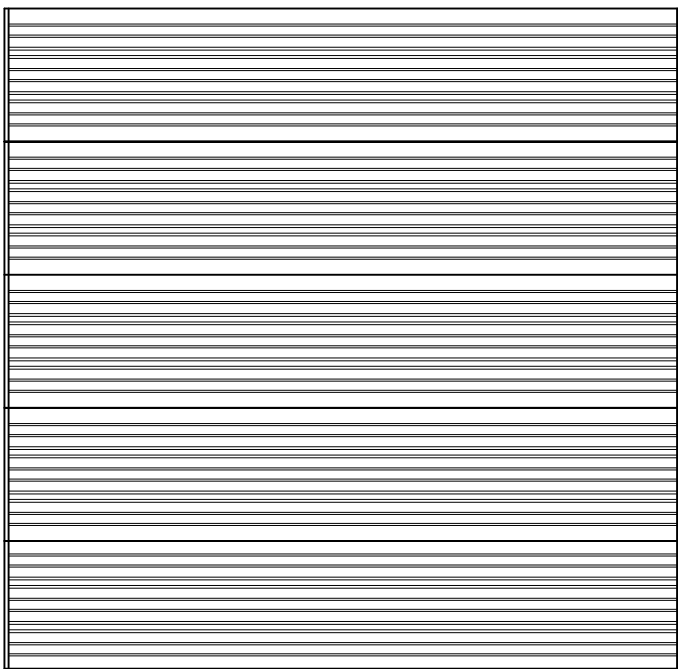

EXTERIOR ELEVATION

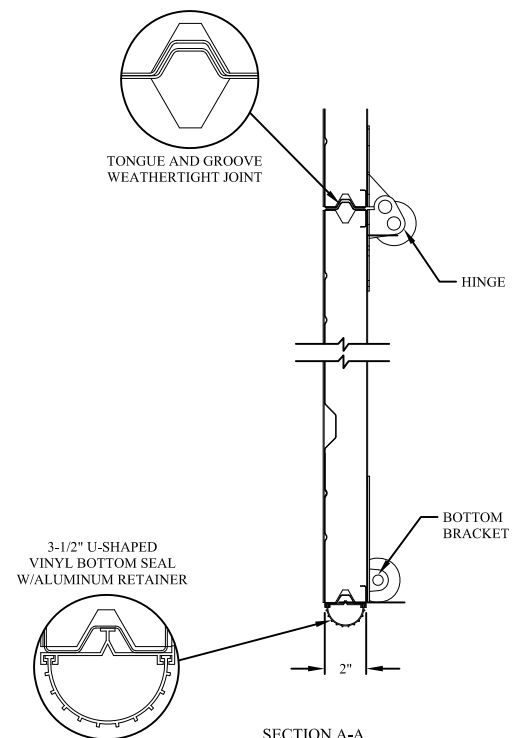

SECTION A-A

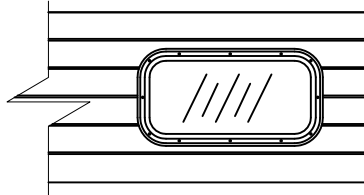

26" x 13 1/2" DOUBLE PANE INSULATED PLEXI-GLASS

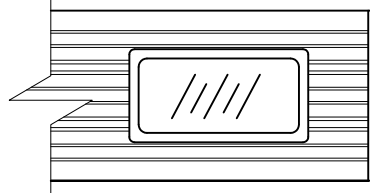

24" x 12" WINDOW W/ NON-INSULATED 1/8" PLEXI-GLASS AND DOUBLE PANE INSULATED PLEXI-GLASS

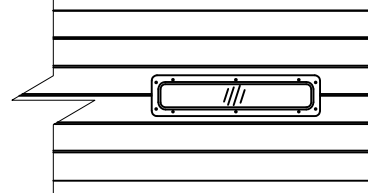

24" x 6" WINDOW WITH 1/8" PLEXI-GLASS AND DOUBLE PANE INSULATED PLEXI-GLASS

DOOR WIDTH	MAX No. WINDOWS	DOOR WIDTH	MAX No. WINDOWS
8'2"	2	17'2"	5
9'2"	2	18'2"	5
10'2"	3	19'2"	5
11'2"	3	20'2"	6
12'2"	3	21'2"	6
13'2"	4	22'2"	6
14'2"	4	23'2"	6
15'2"	4	24'2"	6
16'2"	4		

NOTE: CHART ABOVE INDICATES MAXIMUM NUMBER OF WINDOWS PER SECTION.

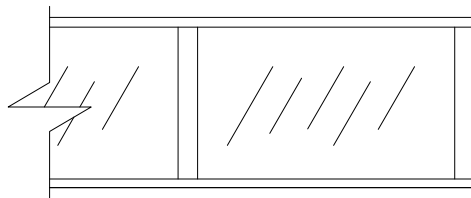

ALUMINUM FULLVIEW SECTION

DOOR WIDTH	DOOR HEIGHTS																	
	7'1"	8'1"	9'1"	10'1"	11'1"	12'1"	13'1"	14'1"	15'1"	16'1"	17'1"	18'1"	19'1"	20'1"	21'1"	22'1"	23'1"	24'1"
8'2" - 12'2"	4	4	5	5	6	6	7	7	8	8	9	9	10	10	11	11	12	12
12'4" - 16'2"	2	2	3	3	4	4	5	5	6	6	7	7	8	8	9	9	10	10
16'4" - 24'2"	2	2	2	2	2	2	2	2	2	2	2	2	2	2	2	2	2	2

NOTE: CHART ABOVE INDICATES MAXIMUM NUMBER OF ALUMINUM FULLVIEW SECTIONS PER DOOR SIZE.

DOOR WIDTH	MAX No. PANELS	DOOR WIDTH	MAX No. PANELS
8'2"	2	17'2"	5
9'2"	2	18'2"	5
10'2"	3	19'2"	5
11'2"	3	20'2"	6
12'2"	3	21'2"	6
13'2"	4	22'2"	6
14'2"	4	23'2"	6
15'2"	4	24'2"	6
16'2"	4		

NOTE: CHART ABOVE INDICATES MAXIMUM NUMBER OF PANELS PER SECTION.

SECTION ARRANGEMENT CHART

Door Height	21" Bottom	21" Intermediate	24" Bottom	24" Intermediate
7'0"	1	3		
7'3"		3	1	
7'6"		2	1	1
7'9"		1	1	2
8'0"				4
8'3"	Not Available			
8'6"	Not Available			
8'9"	1	4		
9'0"		4	1	
9'3"		3	1	1
9'6"		2	1	2
9'9"		1	1	3
10'0"			1	4
10'3"	Not Available			
10'6"	1	5		
10'9"		5	1	
11'0"		4	1	1
11'3"		3	1	2
11'6"		2	1	3
11'9"		1	1	4
12'0"			1	5
12'3"	1	6		
12'6"		6	1	
12'9"		5	1	1
13'0"		4	1	2
13'3"		3	1	3
13'6"		2	1	4
13'9"		1	1	5
14'0"			1	6
14'0"	1	7		
14'3"		7	1	
14'6"		6	1	1
14'9"		5	1	2
15'0"		4	1	3
15'3"		3	1	4
15'6"		2	1	5
15'9"		1	1	6
15'9"	1	8		
16'0"			1	7
16'0"		8	1	
16'3"		7	1	1
16'6"		6	1	2
16'9"		5	1	3
17'0"		4	1	4
17'3"		2	1	5
17'6"		2	1	6
17'9"		1	1	7
18'0"			1	8
18'3"		7	1	2
18'6"		6	1	3
18'9"		5	1	4
19'0"		4	1	5
19'3"		3	1	6
19'6"		2	1	7
19'9"		1	1	8
20'0"			1	9
22'0"			1	10
24'0"			1	11